

Holzverbindungen



Holzverbindungen



GEBR. BODEGRAVEN BV
Verbindungen für den Bau

Artikel	Seite
A	
Ankereisen	13
Ankernägel mit Drallgewinde	35
Ankerplatte	20
Ankerstreifen	14,24
B	
Balkenanker	23
Balkenauflegeplatte	19
Balkenauflegeplatte F-Modell	18
Balkenschuhe doppelt	7
Balkenschuhe medium	3
Balkenschuhe schwer	1,2
Balkenschuhe mit kurzer Lasche	5
Balkenschuhe mit langer Lasche	4
Balkenschuhe ohne Lasche	6
Balkenträger mit Keilbolzen	36
Balkenverbinder	10,11
Baukeile	15
Breitwinkel	33
D	
Distanzplatten	15
E	
Eckverbinder	24
Einlassecken 90°	33
Einpressdübel	12
Eye-safe für Winkelverbinder	32
F	
Faltwinkel	31
Firstlattenhalter	26
Flachstahl-Winkel	21
Flachverbinder	13,14
G	
Gerüstbrettband	32
H	
Hakenschrauben	19
Hochdruckplatten	17
HSB-Zuganker	23
J	
Justierplatte	12,15
K	
Kammnägel	35
Konsolenstütze	36

Artikel	Seite
Kreuzwinkel	34
M	
Mauerplattenhaken	23
Mauerwerksmontageplatten	20
Möbelwinkel	32
Montageplatten	16
Multinagelplatte	12
P	
Pfannenklammern	26
Pfettenverbinder	8
Profillochplatte	12
Q	
Querholzverbinder	9
S	
Schraubnägel	35
Sparrenwinkel	24
Spreizdübel	35
Stahlklemmscheibe	26
Stahlnagel Z1	35
Steinanker mit Platte	21
Stuhlwinkel	32,33
T	
T-Träger Balkenanker	25
T-Winkel	34
U	
Universalverbinder	9
U-Winkel	14
V	
Verbindungsblech	13
W	
Windrispenband	25
Windsoganker	21,22
Winkelverbinder	24-31
Winkelverbinder 90°	24
Winkelverbinder 135°	24
Winkelverbinder mit Wulst	28-31
Z	
Zuganker	23

Artikel Nr.	Verp. (Bestell) Einheit	EAN-Code Verpackung 8714318	für Holzbalken mm	Anzahl der Bohrungen Anzahl / mm	Abmessung B x H mm	Material mm	Oberfläche
-------------	-------------------------	-----------------------------	-------------------	----------------------------------	--------------------	-------------	------------

Balkenschuhe schwer 2 mm

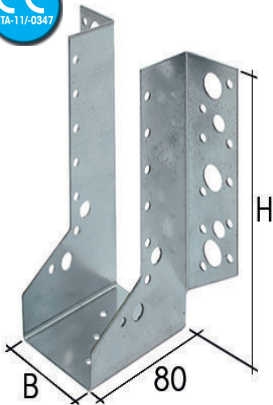

Art.Nr. 078440

Andere Holzgrößen auf Anfrage

078200*	50	117313	38x125	25/4-6/9-4/14	38x121	2	SV
078110*	50	103477	46x96	17/4-6/9-2/14	46x87	2	SV
078210*	50	103491	46x121	25/4-6/9-4/14	46x117	2	SV
078310*	50	103538	46x146	33/4-8/9-4/14	46x144	2	SV
078410*	50	103590	46x171/196	37/4-8/9-6/14	46x167	2	SV
078120*	50	103484	50x100	17/4-6/9-2/14	50x85	2	SV
078220*	50	103507	50x125	25/4-6/9-4/14	50x115	2	SV
078320*	50	103545	50x150	33/4-8/9-4/14	50x143	2	SV
078420*	50	103606	50x175	37/4-8/9-6/14	50x165	2	SV
078230*	50	103514	59x121	25/4-6/9-4/14	59x110	2	SV
078330*	50	103552	59x146/156	33/4-8/9-4/14	59x138	2	SV
078430*	50	103613	59x171	37/4-8/9-6/14	59x160	2	SV
078530*	40	103668	59x196	45/4-10/9-6/14	59x190	2	SV
07863*s	1	010324	59x221	51/4-10/9-8/14	59x220	2	SV
078140*	50	802134	63x100	17/4-6/9-2/14	63x78	2	SV
078240*	50	103521	63x125	25/4-6/9-4/14	63x108	2	SV
078340*	50	103569	63x150	33/4-8/9-4/14	63x136	2	SV
078440*	50	103620	63x160/175	37/4-8/9-6/14	63x158	2	SV
078540*	40	103675	63x200	45/4-10/9-6/14	63x188	2	SV
07864*s	1	010331	63x225	51/4-10/9-8/14	63x218	2	SV
078350*	50	103576	71x146	33/4-8/9-4/14	71x132	2	SV
078450*	50	103637	71x171	37/4-8/9-6/14	71x154	2	SV
078550*	40	103682	71x196	45/4-10/9-6/14	71x184	2	SV
078650*	40	103743	71x221/246	51/4-10/9-8/14	71x214	2	SV
078750*	25	103781	71x271	59/4-10/9-8/14	71x245	2	SV
078360*	50	103583	75x150	33/4-8/9-4/14	75x130	2	SV
078460*	50	103644	75x175	37/4-8/9-6/14	75x152	2	SV
078560*	40	103699	75x200	45/4-10/9-6/14	75x182	2	SV
078660*	40	103750	75x225	51/4-10/9-8/14	75x212	2	SV
07876*s	1	003951	75x250	59/4-10/9-8/14	75x242	2	SV
07886 s	1	003982	75x275	71/4-4/9-6/14	75x272	2	SV
078570*	40	113193	96x196	45/4-10/9-6/14	96x172	2	SV
078670*	40	113216	96x221	51/4-10/9-8/14	96x202	2	SV
078770*	1	041724	96x246	59/4-10/9-8/14	96x232	2	SV
078580*	40	113209	100x200	45/4-10/9-6/14	100x170	2	SV
07868*s	1	010348	100x225	51/4-10/9-8/14	100x200	2	SV
078780*	1	016968	100x250	59/4-10/9-8/14	100x230	2	SV

* CE - zertifiziert

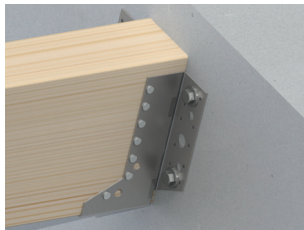

Weitere Informationen finden Sie in unserem Technik-Buch, welches auf unserer Homepage zum Download bereit steht.

Auf Anfrage auch in V2A lieferbar.

SV = sendzimir verzinkt; **304** = RVS VA2

Artikel Nr.	Verp. (Bestell) Einheit	EAN-Code Verpackung	für Holzbalken mm	Anzahl der Bohrungen Anzahl / mm	Abmessung B x H mm	Material mm	Oberfläche
-------------	-------------------------	---------------------	-------------------	----------------------------------	--------------------	-------------	------------

Balkenschuhe schwer Typ A

078910	50	118938	60x100	21/4,5-6/9-2/14	60x100	2	SV
078915	50	118945	80x120	29/4,5-6/9-2/14	80x120	2	SV
078920	50	118952	100x140	37/4,5-8/9-6/14	100x140	2	SV
078925	25	118969	120x160	45/4,5-4/9-4/14	120x160	2	SV
078930	25	118976	140x180	53/4,5-4/9-6/14	140x180	2	SV

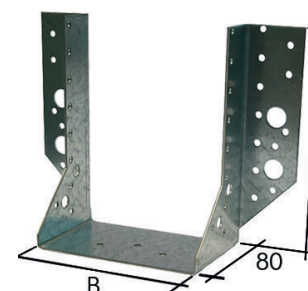

Art.Nr. 078910

Balkenschuhe schwer zweiteilig

0788801	25	045036	18/4,5-6/9-2/14	22x85	2	SV
0788803	25	044763	26/4,5-6/9-4/14	22x115	2	SV
0788805	25	044794	34/4,5-8/9-4/14	22x143	2	SV
0788807	25	044800	38/4,5-8/9-6/14	22x165	2	SV
0788809	25	045456	46/4,5-10/9-6/14	22x195	2	SV
0788811	25	045463	52/4,5-10/9-8/14	22x225	2	SV
0788813	25	045470	60/4,5-10/9-8/14	22x255	2	SV
0788815	25	045487	72/4,5-4/9-6/14	22x285	2	SV

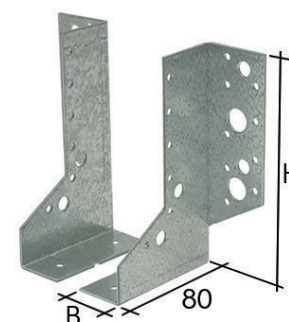

Art.Nr. 0788803

Der Balkenschuh schwer besteht aus zwei Teilen

Artikel Nr.	Verp. (Bestell) Einheit	EAN-Code Verpackung 8714318	für Holzbalken mm	Anzahl der Bohrungen Anzahl / mm	Abmessung B x H mm	Material mm	Oberfläche
-------------	-------------------------	-----------------------------	-------------------	----------------------------------	--------------------	-------------	------------

Balkenschuhe medium

NEU

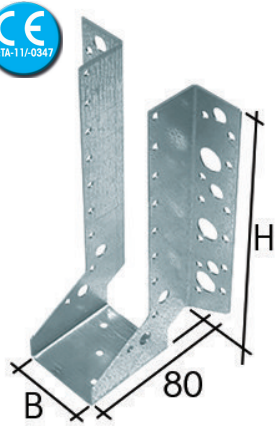

Art.Nr. 0777110

0777200*	10	047283	38x121	25/4-6/9-4/14	280/38x121	1,5	SV
0777010*	10	038250	46x71	11/4-6/9	180/46x67	1,5	SV
0777110*	10	034481	46x96	21/4-6/9-2/14	230/46x92	1,5	SV
0777210*	10	034467	46x121	25/4-6/9-4/14	280/46x117	1,5	SV
0777310*	10	034511	46x146	33/4-8/9-4/14	335/46x144	1,5	SV
0777020*	10	038281	50x75/100	11/4-6/9	180/50x65	1,5	SV
0777220*	10	034672	50x125	25/4-6/9-4/14	280/50x115	1,5	SV
0777320*	10	034528	50x150	33/4-8/9-4/14	335/50x143	1,5	SV
0777230*	10	034696	59x121	25/4-6/9-4/14	280/59x110	1,5	SV
0777330*	10	034559	59x146/156	33/4-8/9-4/14	335/59x138	1,5	SV
0777430*	50	034726	59x171	37/4-8/9-6/14	380/59x160	1,5	SV
0777240*	10	034719	63x125	25/4-6/9-4/14	280/63x108	1,5	SV
0777340*	10	034573	63x150	33/4-8/9-4/14	335/63x136	1,5	SV
0777440*	50	034610	63x160/175	37/4-8/9-6/14	380/63x158	1,5	SV
0777350*	10	034597	71x146	33/4-8/9-4/14	335/71x132	1,5	SV
0777450*	50	034740	71x171	NEU 37/4-8/9-6/14	380/71x154	1,5	SV
0777360*	10	034603	75x150	33/4-8/9-4/14	335/75x130	1,5	SV

* CE - zertifiziert



Mehr Informationen finden Sie in unserem Technik-Buch, welches auf unserer Homepage zum Download bereit steht.

Auf Anfrage auch in V2A lieferbar.

Artikel Nr.	Verp. (Bestell) Einheit	EAN-Code Verpackung 8714318	für Holzbalken mm	Anzahl der Bohrungen Anzahl / mm	Abmessung B x H mm	Material mm	Oberfläche
-------------	-------------------------	-----------------------------	-------------------	----------------------------------	--------------------	-------------	------------

Balkenschuhe mit langer Lasche NEU

09311	10	062682	46x96	14/4-2/9-1/14	46x96	1,5	SV
09312	10	062729	46x121	16/4-2/9-1/14	46x121	1,5	SV
09313	10	062651	46x146	20/4-2/9-1/14	46x146	1,5	SV
09315	10	064181	46x171	20/4-2/9-1/14	46x171	1,5	SV
09316	10	064337	46x196	20/4-2/9-1/14	46x196	1,5	SV
09321	10	063337	50x100	14/4-2/9-1/14	50x100	1,5	SV
09322	10	063351	50x125	16/4-2/9-1/14	50x125	1,5	SV
09323	10	063320	50x150	20/4-2/9-1/14	50x150	1,5	SV
09325	10	064273	50x175	20/4-2/9-1/14	50x175	1,5	SV
09326	10	064334	50x200	20/4-2/9-1/14	50x200	1,5	SV
09332	10	064341	59x121	18/4-2/9-1/14	59x121	1,5	SV
09333	10	064358	59x146	20/4-2/9-1/14	59x146	1,5	SV
09334	10	062156	59x156	20/4-2/9-1/14	59x156	1,5	SV
09335	10	062194	59x171	20/4-2/9-1/14	59x171	1,5	SV
09336	10	064365	59x196	22/4-2/9-1/14	59x196	1,5	SV
09337	10	064372	59x221	22/4-2/9-1/14	59x221	1,5	SV
09342	10	063146	63x125	18/4-2/9-1/14	63x125	1,5	SV
09343	10	064389	63x150	20/4-3/9-1/14	63x150	1,5	SV
09344	10	063184	63x160	20/4-2/9-1/14	63x160	1,5	SV
09345	10	063290	63x175	19/4-2/9-1/14	63x175	1,5	SV
09346	10	064396	63x200	22/4-2/9-1/14	63x200	1,5	SV
09347	10	064402	63x225	20/4-2/9-1/14	63x225	1,5	SV
09352	10	064419	71x121	19/4-2/9-1/14	71x121	1,5	SV
09353	10	062859	71x146	19/4-2/9-1/14	71x146	1,5	SV
09355	10	062842	71x171	23/4-2/9-2/14	71x171	1,5	SV
09356	10	062828	71x196	23/4-2/9-2/14	71x196	1,5	SV
09357	10	062798	71x221	27/4-3/9-2/14	71x221	1,5	SV
09358	10	062781	71x246	27/4-3/9-2/14	71x246	1,5	SV
09359	10	062774	71x271	27/4-3/9-2/14	71x271	1,5	SV
09362	10	064426	75x125	19/4-2/9-1/14	75x125	1,5	SV
09363	10	063283	75x150	19/4-2/9-1/14	75x150	1,5	SV
09365	10	062873	75x175	23/4-2/9-2/14	75x175	1,5	SV
09366	10	063313	75x200	23/4-2/9-2/14	75x200	1,5	SV
09367	10	063696	75x225	27/4-3/9-2/14	75x225	1,5	SV
09368	10	063467	75x250	27/4-3/9-2/14	75x250	1,5	SV
09369	10	064433	75x275	27/4-3/9-2/14	75x275	1,5	SV
09376	10	062880	96x196	23/4-2/9-2/14	96x196	1,5	SV
09377	10	062927	96x221	25/4-2/9-2/14	96x221	1,5	SV
09378	10	062941	96x246	25/4-2/9-2/14	96x246	1,5	SV
09386	10	063153	100x200	23/4-2/9-2/14	100x200	1,5	SV
09387	10	063160	100x225	25/4-2/9-2/14	100x225	1,5	SV
09388	10	063177	100x250	25/4-2/9-2/14	100x250	1,5	SV

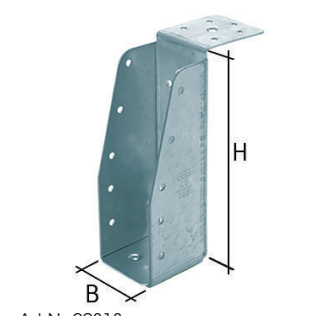

Art.Nr. 09313

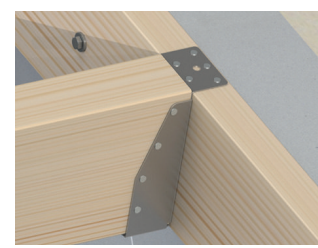

Systembeschreibung:

Verwenden Sie die im Technik-Buch beschriebene Befestigung in der Rückplatte, dem seitlichen Flansch und der oberen Lasche.

Wenn der Balkenschuh nicht mit der beschriebenen Befestigung in der Rückplatte befestigt ist, sonder nur an der Lasche, können keine so wie im Technik-Buch beschriebenen Kräfte zugewiesen werden.

Mehr Informationen finden Sie in unserem Technik-Buch, welches auf unserer Homepage zum Download bereit steht.

Auf Anfrage auch in V2A lieferbar.

Balkenschuhe mit langer Lasche Bohrung 7 mm

09355	10	053842	71x171	23/4-2/9-2/14	71x171	1,5	SV
09356	10	062828	71x196	23/4-2/9-2/14	71x196	1,5	SV
09376	10	062880	96x196	23/4-2/9-2/14	96x196	1,5	SV



Artikel Nr.	Verp. (Bestell) Einheit	EAN-Code Verpackung 8714318	für Holzbalken mm	Anzahl der Bohrungen Anzahl / mm	Abmessung B x H mm	Material mm	Oberfläche
-------------	-------------------------	-----------------------------	-------------------	----------------------------------	--------------------	-------------	------------

Balkenschuhe mit kurzer Lasche

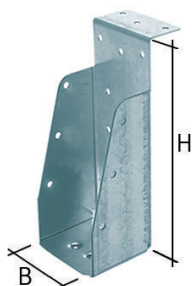

Art.Nr. 09434

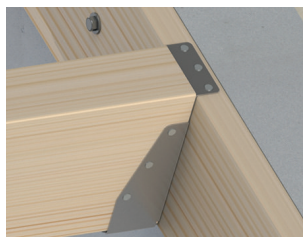

09411	10	062699	46x96	11/4-2/9-1/14	46x96	1,5	SV
09412	10	062705	46x121	14/4-2/9-1/14	46x121	1,5	SV
09413	10	062668	46x146	16/4-2/9-1/14	46x146	1,5	SV
09415	10	063054	46x171	20/4-2/9-1/14	46x171	1,5	SV
09416	10	064440	46x196	20/4-2/9-1/14	46x196	1,5	SV
09421	10	064457	50x100	11/4-2/9-1/14	50x100	1,5	SV
09422	10	064464	50x125	14/4-2/9-1/14	50x125	1,5	SV
09423	10	062644	50x150	16/4-2/9-1/14	50x150	1,5	SV
09425	10	064471	50x175	18/4-2/9-1/14	50x175	1,5	SV
09426	10	064488	50x200	20/4-2/9-1/14	50x200	1,5	SV
09432	10	064501	59x121	15/4-2/9-1/14	59x121	1,5	SV
09433	10	064518	59x146	18/4-2/9-1/14	59x146	1,5	SV
09434	10	062637	59x156	18/4-2/9-1/14	59x156	1,5	SV
09435	10	063344	59x171	20/4-2/9-1/14	59x171	1,5	SV
09436	10	064525	59x196	20/4-2/9-1/14	59x196	1,5	SV
09437	10	064532	59x221	22/4-2/9-1/14	59x221	1,5	SV
09442	10	064549	63x125	18/4-2/9-1/14	63x125	1,5	SV
09443	10	064556	63x150	18/4-2/9-1/14	63x150	1,5	SV
09444	10	064198	63x160	18/4-2/9-1/14	63x160	1,5	SV
09445	10	064563	63x175	20/4-2/9-1/14	63x175	1,5	SV
09446	10	064570	63x200	20/4-2/9-1/14	63x200	1,5	SV
09447	10	064587	63x225	24/4-2/9-1/14	63x225	1,5	SV
09453	10	062866	71x146	19/4-2/9-1/14	71x146	1,5	SV
09455	10	062835	71x171	19/4-2/9-1/14	71x171	1,5	SV
09456	10	062811	71x196	23/4-2/9-2/14	71x196	1,5	SV
09457	10	062804	71x221	23/4-2/9-2/14	71x221	1,5	SV
09458	10	064594	71x246	27/4-3/9-2/14	71x246	1,5	SV
09459	10	064600	71x271	27/4-3/9-2/14	71x271	1,5	SV
09463	10	064617	75x150	19/4-2/9-1/14	75x150	1,5	SV
09465	10	064624	75x175	19/4-2/9-1/14	75x175	1,5	SV
09466	10	064631	75x200	23/4-2/9-2/14	75x200	1,5	SV
09467	10	064648	75x225	23/4-2/9-2/14	75x225	1,5	SV
09468	10	064655	75x250	27/4-3/9-2/14	75x250	1,5	SV
09469	10	064662	75x275	27/4-3/9-2/14	75x275	1,5	SV
09476	10	062934	96x196	23/4-2/9-2/14	96x196	1,5	SV
09477	10	062897	96x221	23/4-2/9-2/14	96x221	1,5	SV
09478	10	062910	96x246	25/4-2/9-2/14	96x246	1,5	SV
09486	10	063276	100x200	23/4-2/9-2/14	100x200	1,5	SV
09487	10	063689	100x225	23/4-2/9-2/14	100x225	1,5	SV
09488	10	064679	100x250	25/4-2/9-2/14	100x250	1,5	SV

Systembeschreibung:

Verwenden Sie die im Technik-Buch beschriebene Befestigung in der Rückplatte, dem seitlichen Flansch und der oberen Lasche.

Wenn der Balkenschuh nicht mit der beschriebenen Befestigung in der Rückplatte befestigt ist, sonder nur an der Lasche, können keine so wie im Technik-Buch beschriebenen Kräfte zugewiesen werden.

Mehr Informationen finden Sie in unserem Technik-Buch, welches auf unserer Homepage zum Download bereit steht.

Auf Anfrage auch in V2A lieferbar.

SV = sendzimir verzinkt; **304** = RVS VA2

Artikel Nr.	Verp. (Bestell) Einheit	EAN-Code Verpackung 8714318	für Holzbalken mm	Anzahl der Bohrungen Anzahl / mm	Abmessung B x H mm	Material mm	Oberfläche
-------------	-------------------------	-----------------------------	-------------------	----------------------------------	--------------------	-------------	------------

Balkenschuhe ohne Lasche

09511	10	064174	46x96	9/4-2/9-1/14	46x96	1,5	SV
09512	10	062712	46x121	14/4-2/9-1/14	46x121	1,5	SV
09513	10	062675	46x146	16/4-2/9-1/14	46x146	1,5	SV
09515	10	063795	46x171	20/4-2/9-1/14	46x171	1,5	SV
09516	10	063801	46x196	20/4-2/9-1/14	46x196	1,5	SV
09521	10	063818	50x100	14/4-2/9-1/14	50x100	1,5	SV
09522	10	063825	50x125	11/4-2/9-1/14	50x125	1,5	SV
09523	10	063191	50x150	13/4-2/9-1/14	50x150	1,5	SV
09525	10	063832	50x175	15/4-2/9-1/14	50x175	1,5	SV
09526	10	063849	50x200	20/4-2/9-1/14	50x200	1,5	SV
09532	10	063856	59x121	15/4-2/9-1/14	59x121	1,5	SV
09533	10	063863	59x146	18/4-2/9-1/14	59x146	1,5	SV
09534	10	063306	59x156	18/4-2/9-1/14	59x156	1,5	SV
09535	10	063870	59x171	20/4-2/9-1/14	59x171	1,5	SV
09536	10	064143	59x196	20/4-2/9-1/14	59x196	1,5	SV
09537	10	063924	59x221	19/4-2/9-1/14	59x221	1,5	SV
09542	10	063931	63x125	15/4-2/9-1/14	63x125	1,5	SV
09543	10	063948	63x150	18/4-2/9-1/14	63x150	1,5	SV
09544	10	062217	63x160	18/4-2/9-1/14	63x160	1,5	SV
09545	10	062200	63x175	20/4-2/9-1/14	63x175	1,5	SV
09546	10	063955	63x200	20/4-2/9-1/14	63x200	1,5	SV
09547	10	063962	63x225	21/4-2/9-1/14	63x225	1,5	SV
09553	10	063979	71x146	19/4-2/9-1/14	71x146	1,5	SV
09555	10	063474	71x171	19/4-2/9-1/14	71x171	1,5	SV
09556	10	064259	71x196	23/4-2/9-2/14	71x196	1,5	SV
09557	10	063207	71x221	23/4-2/9-2/14	71x221	1,5	SV
09558	10	063214	71x246	27/4-3/9-2/14	71x246	1,5	SV
09559	10	063986	71x271	24/4-3/9-2/14	71x271	1,5	SV
09563	10	995423	75x150	19/4-2/9-1/14	75x150	1,5	SV
09565	10	064051	75x175	19/4-2/9-1/14	75x175	1,5	SV
09566	10	064242	75x200	23/4-2/9-2/14	75x200	1,5	SV
09567	10	064068	75x225	23/4-2/9-2/14	75x225	1,5	SV
09568	10	064075	75x250	27/4-3/9-2/14	75x250	1,5	SV
09569	10	064082	75x275	27/4-3/9-2/14	75x275	1,5	SV
09576	10	063269	96x196	23/4-2/9-2/14	96x196	1,5	SV
09577	10	064099	96x221	23/4-2/9-2/14	96x221	1,5	SV
09578	10	064105	96x246	25/4-2/9-2/14	96x246	1,5	SV
09586	10	064112	100x200	23/4-2/9-2/14	100x200	1,5	SV
09587	10	064129	100x225	20/4-2/9-2/14	100x225	1,5	SV
09588	10	064136	100x250	20/4-2/9-2/14	100x250	1,5	SV



Art. Nr. 09534

Systembeschreibung:

Verwenden Sie die im Technik-Buch beschriebene Befestigung in der Rückplatte und dem seitlichen Flansch. Wenn der Balkenschuh nicht mit der beschriebenen Befestigung in der Rückplatte befestigt ist, sondern nur an der Lasche, können keine so wie im Technik-Buch beschriebenen Kräfte zugewiesen werden.

Mehr Informationen finden Sie in unserem Technik-Buch, welches auf unserer Homepage zum Download bereit steht.

Auf Anfrage auch in V2A lieferbar.

Artikel Nr.	Verp. (Bestell) Einheit	EAN-Code Verpackung 8714318	für Holzbalken mm	Anzahl der Bohrungen Anzahl / mm	Abmessung B x H mm	Material mm	Oberfläche
-------------	-------------------------	-----------------------------	-------------------	----------------------------------	--------------------	-------------	------------

Balkenschuhe doppelt

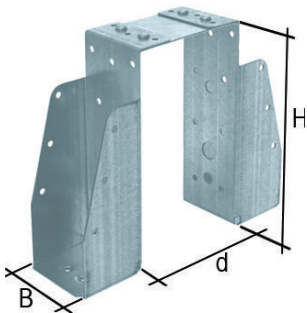

Art.Nr. 09635
Bei der Bestellung Größe d mit angeben. Das Maß 60 bis 180 mm. Auf Anfrage auch 181 bis 380 mm lieferbar.



09611	1	017415	46x96	22/4-4/9-2/14	46x96 d=..	1,5	SV
09612	1	017422	46x121	28/4-4/9-2/14	46x121 d=..	1,5	SV
09613	1	017439	46x146	32/4-4/9-2/14	46x146 d=..	1,5	SV
09615	1	017446	46x171	40/4-4/9-2/14	46x171 d=..	1,5	SV
09616	1	017453	46x196	40/4-4/9-2/14	46x196 d=..	1,5	SV
09621	1	017460	50x100	22/4-4/9-2/14	50x100 d=..	1,5	SV
09622	1	017477	50x125	28/4-4/9-2/14	50x125 d=..	1,5	SV
09623	1	017484	50x150	32/4-4/9-2/14	50x150 d=..	1,5	SV
09625	1	017491	50x175	36/4-4/9-2/14	50x175 d=..	1,5	SV
09626	1	017507	50x200	40/4-4/9-2/14	50x200 d=..	1,5	SV
09632	1	017514	59x121	30/4-4/9-2/14	59x121 d=..	1,5	SV
09633	1	017521	59x146	36/4-4/9-2/14	59x146 d=..	1,5	SV
09634	1	017538	59x156	36/4-4/9-2/14	59x156 d=..	1,5	SV
09635	1	017545	59x171	40/4-4/9-2/14	59x171 d=..	1,5	SV
09636	1	017552	59x196	40/4-4/9-2/14	59x196 d=..	1,5	SV
09637	1	017569	59x221	44/4-4/9-2/14	59x221 d=..	1,5	SV
09642	1	017576	63x125	36/4-4/9-2/14	63x125 d=..	1,5	SV
09643	1	017583	63x150	36/4-4/9-2/14	63x150 d=..	1,5	SV
09644	1	017590	63x160	36/4-4/9-2/14	63x160 d=..	1,5	SV
09645	1	017606	63x175	40/4-4/9-2/14	63x175 d=..	1,5	SV
09646	1	017613	63x200	40/4-4/9-2/14	63x200 d=..	1,5	SV
09647	1	017620	63x225	48/4-4/9-2/14	63x225 d=..	1,5	SV
09653	1	017637	71x146	38/4-4/9-2/14	71x146 d=..	1,5	SV
09655	1	017644	71x171	38/4-4/9-2/14	71x171 d=..	1,5	SV
09656	1	017651	71x196	46/4-4/9-4/14	71x196 d=..	1,5	SV
09657	1	017668	71x221	46/4-4/9-4/14	71x221 d=..	1,5	SV
09658	1	017675	71x246	54/4-6/9-4/14	71x246 d=..	1,5	SV
09659	1	017682	71x271	54/4-6/9-4/14	71x271 d=..	1,5	SV
09663	1	017699	75x150	38/4-4/9-2/14	75x150 d=..	1,5	SV
09665	1	017705	75x175	38/4-4/9-2/14	75x175 d=..	1,5	SV
09666	1	017712	75x200	46/4-4/9-4/14	75x200 d=..	1,5	SV
09667	1	017729	75x225	46/4-4/9-4/14	75x225 d=..	1,5	SV
09668	1	017736	75x250	54/4-6/9-4/14	75x250 d=..	1,5	SV
09669	1	017743	75x275	54/4-6/9-4/14	75x275 d=..	1,5	SV
09676	1	017750	96x196	46/4-4/9-4/14	96x196 d=..	1,5	SV
09677	1	017767	96x221	46/4-4/9-4/14	96x221 d=..	1,5	SV
09678	1	017774	96x246	50/4-4/9-4/14	96x246 d=..	1,5	SV
09686	1	017781	100x200	46/4-4/9-4/14	100x200 d=..	1,5	SV
09687	1	017798	100x225	46/4-4/9-4/14	100x225 d=..	1,5	SV
09688	1	017804	100x250	50/4-4/9-4/14	100x250 d=..	1,5	SV

Systembeschreibung:

Verwenden Sie die im Technik-Buch beschriebene Befestigung in der Rückplatte, dem seitlichen Flansch und der oberen Lasche.

Wenn der Balkenschuh nicht mit der beschriebenen Befestigung in der Rückplatte befestigt ist, sonder nur an der Lasche, können keine so wie im Technik-Buch beschriebenen Kräfte zugewiesen werden.

Mehr Informationen finden Sie in unserem Technik-Buch, welches auf unserer Homepage zum Download bereit steht.

SV = sendzimir verzinkt

Artikel Nr.	Verp. (Bestell) Einheit	EAN-Code Verpackung 8714318	für Holzbalken mm	Anzahl der Bohrungen Anzahl / mm	Abmessung B x H mm	Material mm	Oberfläche
-------------	-------------------------	-----------------------------	-------------------	----------------------------------	--------------------	-------------	------------

Pfettenverbinder

07700	100	103293	32x121/146	19/4	190/32x125	1	SV
07701	100	103309	32x171/196	23/4	225/32x158	1	SV
07702	100	103316	38x125/150	19/4	190/38x121	1	SV
07704	100	103323	38x175/200	23/4	225/38x155	1	SV
07706	50	109028	38x200	30/4	305/38x168	1	SV
07712	100	103330	46x121/146	19/4	190/46x117	1	SV
07714	100	103347	46x171/196	23/4	225/46x153	1	SV
07716	50	109035	46x196	30/4	305/46x164	1	SV
07722	100	103354	50x125/150	19/4	190/50x115	1	SV
07724	100	103361	50x175/200	23/4	225/50x150	1	SV
07726	50	109042	50x200	30/4	305/50x162	1	SV
07732	100	103378	59x121/146	19/4	190/59x110	1	SV
07734	100	103385	59x156/171/196	23/4	225/59x145	1	SV
07736	50	109059	59x196	30/4	305/59x157	1	SV
07742	100	103392	63x125/150	19/4	190/63x108	1	SV
07744	100	103408	63x160/175/200	23/4	225/63x143	1	SV
07746	50	113780	63x200	30/4	305/63x155	1	SV
07752	100	103415	71x146	19/4	190/71x104	1	SV
07754	50	103422	71x171/196	23/4	225/71x139	1	SV
07756	50	103439	71x196	30/4	305/71x151	1	SV
07762	100	103446	75x150	19/4	190/75x102	1	SV
07764	50	103453	75x175/200	23/4	225/75x137	1	SV
07766	50	103460	75x200	30/4	305/75x149	1	SV

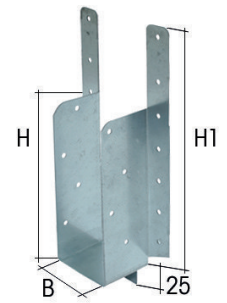

Art.Nr. 07734
 H1 Typ 190 = ca. 175 mm
 H1 Typ 225 = ca. 210 mm
 H1 Typ 305 = ca. 290 - 300 mm



Mehr Informationen finden Sie in unserem Technik-Buch, welches auf unserer Homepage zum Download bereit steht.

Artikel Nr.	Verp. (Bestell) Einheit	EAN-Code Verpackung 8714318	Bezeichnung / Anzahl der Bohrungen Anzahl / mm	Abmessung B x H mm	Material mm	Oberfläche
-------------	-------------------------	-----------------------------	--	--------------------	-------------	------------

Universalverbinder



Art.Nr. 07209

07200	100	105648	A links		1,25	SV
07201	100	105655	A rechts		1,25	SV
07202	100	105662	B links		1,25	SV
07203	100	105679	B rechts		1,25	SV
07209	250	105686	C universal		1,25	SV



Art.Nr. 07200



Art.Nr. 07201



Art.Nr. 07202



Art.Nr. 07203

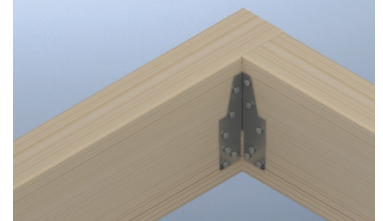

Querholzverbinder

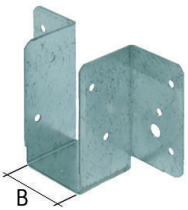

Art.Nr. 07908

07905	100	105693	10/4-2/7	b=25	1	SV
07908	100	105709	10/4-2/7	b=32	1	SV
07909	100	105716	10/4-2/7	b=38	1	SV
07910	100	105723	10/4-2/7	b=40	1	SV
07911	100	105730	10/4-2/7	b=46	1	SV
07912	100	105747	10/4-2/7	b=50	1	SV
07915	100	105778	10/4-2/7	b=55	1,25	SV
07913	100	105754	10/4-2/7	b=59	1,25	SV
07914	100	105761	10/4-2/7	b=63	1,25	SV

Querholzverbinder sind auch lieferbar in V2A ab einem Holzmaß von 32 mm.

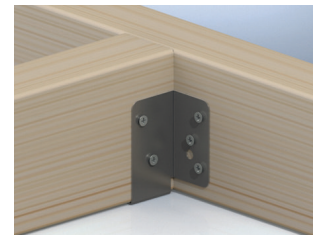

Artikel Nr.	Verp. (Bestell) Einheit	EAN-Code Verpackung 8714318	Anzahl der Bohrungen Anzahl / mm	Abmessung mm	Material mm	Oberfläche
-------------	-------------------------	-----------------------------	----------------------------------	--------------	-------------	------------

Balkenverbinder horizontal

079501	25	105921	10/4	b=38	1,25	SV
07951	25	105938	10/4	b=46	1,25	SV
07952	25	105945	10/4	b=50	1,25	SV
07953	25	105952	10/4	b=59	1,25	SV
07954	25	105969	10/4	b=63	1,25	SV
07955	25	105976	10/4	b=71	1,25	SV
07956	25	105983	10/4	b=75	1,25	SV

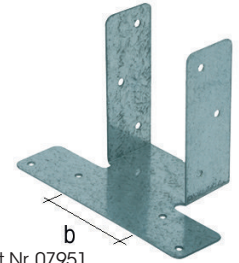

Art.Nr. 07951

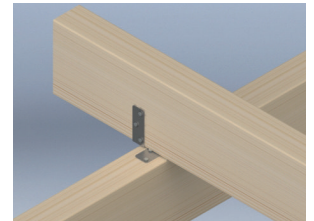

Balkenverbinder vertikal

079601	25	105990	10/4	b=38	1,25	SV
07961	25	106003	10/4	b=46	1,25	SV
07962	25	106010	10/4	b=50	1,25	SV
07963	25	106027	10/4	b=59	1,25	SV
07964	25	106034	10/4	b=63	1,25	SV
07965	25	106041	10/4	b=71	1,25	SV
07966	25	106058	10/4	b=75	1,25	SV

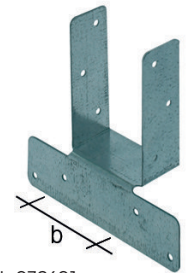

Art.Nr. 079601



Artikel Nr.	Verp. (Bestell) Einheit	EAN-Code Verpackung 8714318	für Holzbalken mm	Anzahl der Bohrungen Anzahl / mm	Abmessung B x H mm	Material mm	Oberfläche
-------------	-------------------------	-----------------------------	-------------------	----------------------------------	--------------------	-------------	------------

GB-Balkenverbinder

NEU



Art.Nr. 0766110

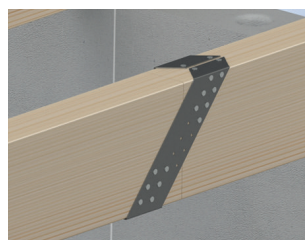

0766110	10	032586	46x96		25/4-2/8	46x96	1,5	SV
0766120	10	032616	46x121		29/4-2/8	46x121	1,5	SV
0766130	10	032630	46x146		33/4-2/8	46x146	1,5	SV
0766150	10	034863	46x171		37/4-2/8	46x171	1,5	SV
0766160	10	034948	46x196		41/4-2/8	46x196	1,5	SV
0766210	10	032654	50x100		25/4-2/8	50x100	1,5	SV
0766220	10	032678	50x125		29/4-2/8	50x125	1,5	SV
0766230	10	032692	50x150		33/4-2/8	50x150	1,5	SV
0766250	10	034962	50x175		37/4-2/8	50x175	1,5	SV
0766260	10	034986	50x200		45/4-2/8	50x200	1,5	SV
0766320	10	035136	59x121		29/4-2/8	59x121	1,5	SV
0766330	10	032715	59x146		33/4-2/8	59x146	1,5	SV
0766340	10	032739	59x156		37/4-2/8	59x156	1,5	SV
0766350	10	032753	59x171		37/4-2/8	59x171	1,5	SV
0766360	10	032777	59x196		45/4-2/8	59x196	1,5	SV
0766370	10	035143	59x221		49/4-2/8	59x221	1,5	SV
0766420	10	035167	63x125		33/4-2/8	63x125	1,5	SV
0766430	10	032791	63x150		37/4-2/8	63x150	1,5	SV
0766440	10	032814	63x160		37/4-2/8	63x160	1,5	SV
0766450	10	032838	63x175		41/4-2/8	63x175	1,5	SV
0766460	10	032852	63x200		49/4-2/8	63x200	1,5	SV
0766470	10	035532	63x225		49/4-2/8	63x225	1,5	SV
0766530	10	035549	71x146		37/4-2/8	71x146	1,5	SV
0766550	10	032876	71x171		41/4-2/8	71x171	1,5	SV
0766560	10	032890	71x196		49/4-2/8	71x196	1,5	SV
0766570	10	032913	71x221		49/4-2/8	71x221	1,5	SV
0766580	10	032937	71x246		53/4-2/8	71x246	1,5	SV
0766590	10	035563	71x271		61/4-2/8	71x271	1,5	SV
0766630	10	035587	75x150		37/4-2/8	75x150	1,5	SV
0766650	10	032951	75x175		45/4-2/8	75x175	1,5	SV
0766660	10	032975	75x200		49/4-2/8	75x200	1,5	SV
0766670	10	032999	75x225		49/4-2/8	75x225	1,5	SV
0766680	10	033019	75x250		53/4-2/8	75x250	1,5	SV
0766690	10	033033	75x275		61/4-2/8	75x275	1,5	SV
0766760	10	033057	96x196		49/4-2/8	96x196	1,5	SV
0766770	10	033071	96x221		53/4-2/8	96x221	1,5	SV
0766780	10	033095	96x246		61/4-2/8	96x246	1,5	SV
0766860	10	033118	100x200		49/4-2/8	100x200	1,5	SV
0766870	10	033132	100x225		53/4-2/8	100x225	1,5	SV
0766880	10	033156	100x250		61/4-2/8	100x250	1,5	SV
0767430	10	045692	59x156		37/4-2/8	59x156	1,5	304
0767431	10	053024	59x171	NEU	41/4-2/8	59x171	1,5	304
0767440	10	037017	63x160		37/4-2/8	63x160	1,5	304
0767450	10	037031	63x175		41/4-2/8	63x175	1,5	304
0767550	10	037055	71x171		41/4-2/8	71x171	1,5	304
0767560	10	037079	71x196		49/4-2/8	71x196	1,5	304
0767570	10	037093	71x221		49/4-2/8	71x221	1,5	304
0767580	10	037116	71x246		53/4-2/8	71x246	1,5	304
0767590	10	037130	71x271	NEU	61/4-2/8	71x271	1,5	304
0767650	10	037154	75x175		45/4-2/8	75x175	1,5	304
0767660	10	037178	75x200		49/4-2/8	75x200	1,5	304
0767670	10	037192	75x225		49/4-2/8	75x225	1,5	304
0767750	10	044695	96x196		49/4-2/8	96x196	1,5	304
0767760	10	044718	96x221		49/4-2/8	96x221	1,5	304

Die Balkenverbinder sind ausschließlich im statischen Nullpunkt zu montieren.

Mehr Informationen finden Sie in unserem Technik-Buch, welches auf unserer Homepage zum Download bereit steht.

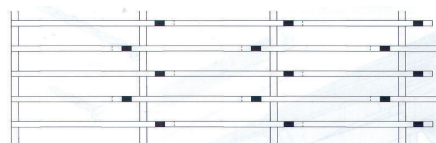

SV = sendzimir verzinkt; **304** = RVS VA2

Artikel Nr.	Verp. (Bestell) Einheit	EAN-Code Verpackung 8714318	Anzahl der Bohrungen mm	Abmessung B x H mm	Material mm	Oberfläche
-------------	-------------------------	-----------------------------	-------------------------	--------------------	-------------	------------

Profillochplatte

072510	100	116866	7/4	75x50	1,25	SV
072520	100	116903	14/4	75x106	1,25	SV
072530	50	116934	21/4	75x150	1,25	SV
072540	25	116927	28/4	75x200	1,25	SV
072550	25	116897	35/4	75x256	1,25	SV
072560	25	116910	42/4	75x300	1,25	SV
07261	100	105099	10/4	106x50	1,25	SV
072620	50	116941	20/4	106x106	1,25	SV
07263	100	105112	30/4	106x150	1,25	SV
07264	25	105129	40/4	106x200	1,25	SV
072650	25	116958	50/4	106x256	1,25	SV
07266	25	105143	60/4	106x300	1,25	SV
07271	50	105150	15/4	150x50	1,25	SV
072720	50	116880	30/4	150x106	1,25	SV
07273	50	105174	45/4	150x150	1,25	SV
07274	50	105181	60/4	150x200	1,25	SV
072750	25	116873	75/4	150x256	1,25	SV
07276	25	105204	90/4	150x300	1,25	SV

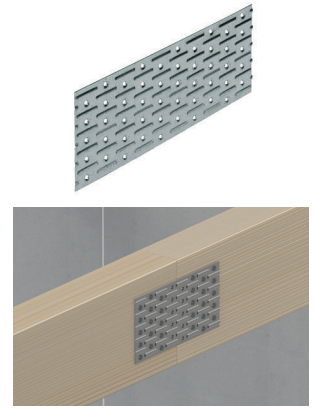

Profillochplatte abgewinkelt

07277	25	105211	90/4	300x120x30	1,25	SV
-------	----	--------	------	------------	------	----

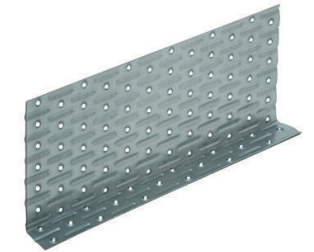

Multinagelplatte

07280	1200	046705		25x101	1	SV
07281	600	046736		38x127	1	SV
07279	320	046620		76x127	1	SV

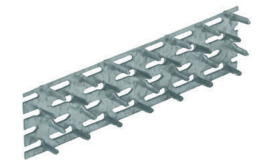

Einpressdübel doppelseitig

07282	200	106195		Ø17	50	SV
07283	100	106201		Ø21	62	SV
07284	100	106218		Ø26	75	SV
07285	40	106225		Ø33	95	TV
07286	25	106232		Ø48	117	TV



Justierplatte







21281	250	114787		40x40	0,7	SV
21285	250	114794		40x60	0,7	SV



Artikel Nr.	Verp. (Bestell) Einheit	EAN-Code Verpackung 8714318	Anzahl der Bohrungen mm	Abmessung mm	Material mm	Oberfläche
-------------	-------------------------	-----------------------------	-------------------------	--------------	-------------	------------

Verbindungsblech

NEU

	82210	100	126902	4/4,5	50	15x2	ZM
	82215	100	126919	4/4,5	80	15x2	ZM
	82220	100	126926	8/3	95	15x2	ZM
	82225	100	126933	4/5	105	15x2	ZM
	82230	100	126940	4/5	135	20x2	ZM
	82245	100	126964	6/5	157	20x2	ZM
	82240	100	126957	5/5	165	20x2	ZM
	82250	100	026349	6/5	200	20x2	ZM
	82306	50	115654	8/5,5	200	36x4	SV
	82307	50	116408	30/5	400	40x2	SV
	823071	50	057817	30/5-1/13	400	40x2	SV
	82308	25	124571	45/5	600	40x2	SV
	82309	25	124588	60/5	800	40x2	SV
	82310	10	124595	75/5	1000	40x2	SV
	82311	10	124601	90/5	1200	40x2	SV
	854504	50	045722	50/5	400	60x2	SV
	854506	25	045890	75/5	600	60x2	SV

Flachverbinder

01220	100	106065	8/4-2/9	200	30x2	SV
01221	100	106072	12/4-4/9	300	30x2	SV
01222	100	106089	12/4-2/9	400	30x2	SV

Art.Nr. 01220

Art.Nr. 01221

Art.Nr. 01222

Ankereisen

01411	25	106096	4/7	300	30x5	VB
01412	25	106102	6/7	400	30x5	VB

Art.Nr. 01411

Artikel Nr.	Verp. (Bestell) Einheit	EAN-Code Verpackung 8714318	Anzahl der Bohrungen mm	Langloch	Abmessung mm	Material mm	Oberfläche
-------------	-------------------------	-----------------------------	-------------------------	----------	--------------	-------------	------------

Ankerstreifen

01502	25	106119	12/6		200	30x5	VB
01504	25	106126	24/6		400	30x5	VB
01506	10	106133	36/6		600	30x5	VB
01508	10	106140	48/6		800	30x5	VB
01510	10	106157	60/6		1000	30x5	VB
01512	1	006723	72/6		1200	30x5	VB
01520	1	040185	120/6		2000	30x5	VB

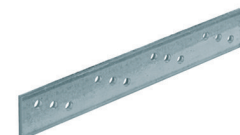

Art.Nr. 01502

Flachverbinder

073190	30	062132	8/7-6/9-1/13	2/ 30x11	175	70x4	SV
072210	50	113971	10/4-6/6-4/9-1/11	30x11	180	60x2,5	SV
07238	50	998851	12/4-8/6-5/9-2/11	30x11	240	60x2,5	SV
07224	50	106171	10/4-6/6-1/11	20x10	250	46x2,5	SV
07227	50	106188	15/4-10/6-5/9	2/30x11	300	60x2,5	SV
073199	30	051099	12/7-10/9-3/13	2/30x13	270	70x5	SV
017315	20	067601	16/7-18/9-5/13	2/30x13	NEU 315	70x5	SV
017415	15	067588	20/7-24/9-5/13	4/30x13	NEU 415	70x5	SV



Art.Nr. 072210



Art.Nr. 073199



Art.Nr. 017315



Art.Nr. 017415

U-Winkel zur Befestigung der Lattung

01038	100	046910	6/4-1/10	CLS houtmaat	38x75x85	30x2	SV
01046	100	047191	6/4-1/10		46x71x95	30x2	SV
01059	100	047214	6/4-1/10		59x65x105	30x2	SV



Für schnell und genaue Befestigung der Unterkonstruktion.



Art. Nr. 01038

SV = sendzimir verzinkt; VB = verzinktes Band

Artikel Nr.	Verp. (Bestell) Einheit	EAN-Code Verpackung	Farbe / Inhalt	Abmessung mm	Material mm	Oberfläche
-------------	-------------------------	---------------------	----------------	--------------	-------------	------------

Distanz- u. Justierplatten im Beutel verpackt



34601	480	029906	durchsichtig:	5 Beutel à 96 Stück	1	50x50	KS
34602	240	029913	orange:	5 Beutel à 48 Stück	2	50x50	KS
34603	192	029944	schwarz:	4 Beutel à 48 Stück	3	50x50	KS
34604	144	029968	blau:	3 Beutel à 48 Stück	4	50x50	KS
34605	144	029975	rot:	3 Beutel à 48 Stück	5	50x50	KS
34607	96	029999	grau:	2 Beutel à 48 Stück	7	50x50	KS
34610	96	030018	grün:	2 Beutel à 48 Stück	10	50x50	KS

Das Maß von dem Schlitz ist 12x37 mm

Distanz- u. Justierplatten in Kunststoff-Dosen



34601	480	030414	durchsichtig		1	50x50	KS
34602	240	030421	orange		2	50x50	KS
34603	192	030438	schwarz		3	50x50	KS
34604	144	030445	blau		4	50x50	KS
34605	144	030452	rot		5	50x50	KS
34607	96	030469	grau		7	50x50	KS
34610	80	030476	grün		10	50x50	KS

Das Maß von dem Schlitz ist 12x37 mm

Distanz- u. Justierplatten in Sortimentsverpackungen



Koffer gefüllt

34650	1	030940	Koffer:	96x1/96x2/48x3/48x4/48x5		50x50	KS
34640	1	031534	Beutel:	96x 1-2 / 48x 3-4-5-7-10		50x50	KS
34600	1	124809	Kunststoff-Dosen:	60x1/40x2-3/20x4-5/10x7-10		50x50	KS

Distanz- u. Justierplatten im Bündel verpackt

NEU



34501	768	066963	durchsichtig:	6 Bündel à 128 Stück	NEU	1	50x50	KS
34502	384	066987	orange:	6 Bündel à 64 Stück	NEU	2	50x50	KS
34503	252	067007	schwarz:	6 Bündel à 42 Stück	NEU	3	50x50	KS
34504	192	067021	blau:	6 Bündel à 32 Stück	NEU	4	50x50	KS
34505	156	067311	rot:	6 Bündel à 26 Stück	NEU	5	50x50	KS
34507	108	067359	grau:	6 Bündel à 18 Stück	NEU	7	50x50	KS
34510	78	067373	grün:	6 Bündel à 13 Stück	NEU	10	50x50	KS
34500	1	067656		128x1-2/84x3/64x4/52x5/18x7/16x10	NEU		50x50	KS

Das Maß von dem Schlitz ist 12x37 mm



Baukeile

NEU

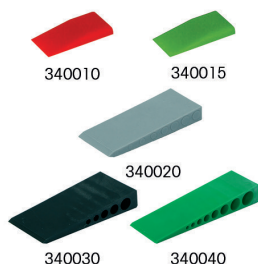

340010	450	047733	rot: In Kunststoff-Dosen			40	23x5	KS
340010	500	125523	rot: Im Beutel			40	23x5	KS
340015	450	060107	grün: In Kunststoff-Dosen		NEU	40	23x5	ABS
340020	100	125530	grau: Im Beutel			70	30x10	KS
340030	50	125547	schwarz: Im Beutel			100	45x18	KS
340040	25	125554	grün: Im Beutel			150	45x25	KS

Baukeile rot Art.Nr. 340010 aus KS sind für Standard-Modulblöcke, leicht zu brechen.
 Baukeile grün Art.Nr. 340015 aus ABS sind für schwere Modulblöcke.

ABS = Acrylnitril-Butadien-Styrol; KS = Kunststoff

Artikel Nr.	Verp. (Bestell) Einheit	EAN-Code Verpackung	Farbe / Inhalt	Abmessung mm	Material mm	Oberfläche
-------------	-------------------------	---------------------	----------------	--------------	-------------	------------

Montageplatten im Beutel verpackt

NEU

34701	480	058616	durchsichtig:	4 Beutel à 96 Stück	NEU	1	70x70	KS
34702	240	030261	orange:	5 Beutel à 48 Stück		2	70x70	KS
34703	240	030247	schwarz:	5 Beutel à 48 Stück		3	70x70	KS
34704	192	030223	blau:	4 Beutel à 48 Stück		4	70x70	KS
34705	192	030209	rot:	4 Beutel à 48 Stück		5	70x70	KS
34706	192	030179	durchsichtig:	4 Beutel à 48 Stück		6	70x70	KS
34707	192	030155	grau:	4 Beutel à 48 Stück		7	70x70	KS
34710	144	030131	grün:	3 Beutel à 48 Stück		10	70x70	KS
34715	48	045821	orange:	1 Beutel à 48 Stück		15	70x70	KS
34720	48	045852	blau:	1 Beutel à 48 Stück		20	70x70	KS
34730	48	045876	schwarz:	1 Beutel à 48 Stück		30	70x70	KS

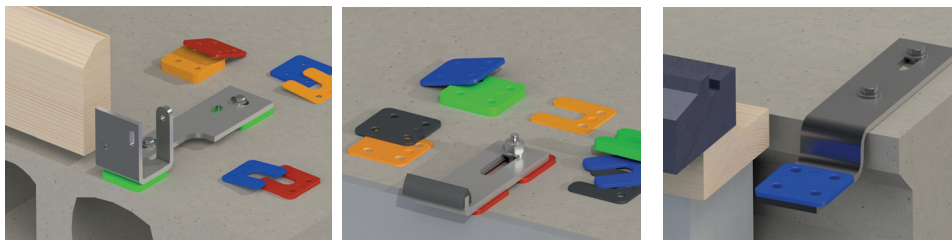

Art.Nr. 34705



Lochbild entspricht Lochmuster der Rahmenbügel

Zulässige gleichmäßig verteilte Last für alle Modelle ohne Schlitz = 6.500 kg

Montageplatten mit Schlitz 45x20 im Beutel verpackt

NEU

34741	480	058647	durchsichtig:	4 Beutel à 96 Stück	NEU	1	70x70	KS
34742	240	030285	orange:	5 Beutel à 48 Stück		2	70x70	KS
34743	240	030308	schwarz:	5 Beutel à 48 Stück		3	70x70	KS
34744	192	030322	blau:	4 Beutel à 48 Stück		4	70x70	KS
34745	192	030346	rot:	4 Beutel à 48 Stück		5	70x70	KS
34746	192	030360	durchsichtig:	4 Beutel à 48 Stück		6	70x70	KS
34747	192	030384	grau:	4 Beutel à 48 Stück		7	70x70	KS
34750	144	030407	grün:	3 Beutel à 48 Stück		10	70x70	KS
34755	48	057718	orange:	3 Beutel à 48 Stück	NEU	15	70x70	KS
34761	48	057732	blau:	3 Beutel à 48 Stück	NEU	20	70x70	KS
34770	48	057756	schwarz:	3 Beutel à 48 Stück	NEU	30	70x70	KS



Das Maß von dem Schlitz ist 20 mm

Zulässige gleichmäßig verteilte Last für die oben genannten Modelle mit Schlitz = 4.500 kg

34760	40	127909	grün:	1 Beutel à 40 Stück		20	70x70	KS
--------------	----	--------	-------	---------------------	--	----	-------	----

Zulässige gleichmäßig verteilte Last für das oben genannte Modell mit Schlitz = 3.500 kg

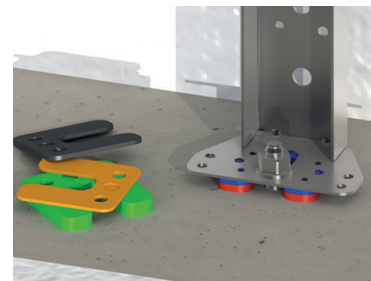

Art.Nr. 34760

Artikel Nr.	Verp. (Bestell) Einheit	EAN-Code Verpackung 8714318	Farbe / Inhalt	Abmessung mm	Material mm	Oberfläche
-------------	-------------------------	-----------------------------	----------------	--------------	-------------	------------

Hochdruckplatten im Beutel verpackt

NEU



Art.Nr. 34805

34802	288	029395	schwarz:	6 Beutel à 48 Stück		2	70x70	ABS
34803	288	060428	schwarz:	6 Beutel à 48 Stück	NEU	3	70x70	ABS
34805	192	029425	schwarz:	4 Beutel à 48 Stück		5	70x70	ABS
34810	192	029456	schwarz:	4 Beutel à 48 Stück		10	70x70	ABS
34820	48	046132	schwarz:	1 Beutel à 48 Stück		20	70x70	ABS

Zulässige gleichmäßig verteilte Last für ABS Platten = 8.500 kg

Die ABS Hochdruckplatten sind hergestellt für eine Anwendung in Kombination mit schweren Konstruktionen.

34902	500	061739	schwarz		NEU	2	100x100	PS
34903	500	061753	schwarz		NEU	3	100x100	PS
34905	250	061777	schwarz		NEU	5	100x100	PS
34910	100	061791	schwarz		NEU	10	100x100	PS

Zulässige gleichmäßig verteilte Last für PS Platten = 12.000 kg

Die PS Hochdruckplatten sind hergestellt für eine Anwendung in Kombination mit schweren Konstruktionen.

Hochdruckplatten mit Schlitz im Beutel verpackt

NEU



Art.Nr. 34843

34842	288	060954	schwarz:	6 Beutel à 48 Stück	NEU	2	70x70	ABS
34843	288	060985	schwarz:	6 Beutel à 48 Stück	NEU	3	70x70	ABS
34845	192	061012	schwarz:	4 Beutel à 48 Stück	NEU	5	70x70	ABS
34850	192	061043	schwarz:	4 Beutel à 48 Stück	NEU	10	70x70	ABS
34860	48	061067	schwarz:	1 Beutel à 48 Stück	NEU	20	70x70	ABS

Zulässige gleichmäßig verteilte Last für ABS Platten = 8.500 kg

Die ABS Hochdruckplatten sind hergestellt für eine Anwendung in Kombination mit schweren Konstruktionen.

Artikel Nr.	Verp. (Bestell) Einheit	EAN-Code Verpackung 8714318	Holzmaß	Lochmuster / Langlöcher Anzahl / mm	Abmessung mm	Größe mm	Oberfläche
-------------	-------------------------	-----------------------------	---------	-------------------------------------	--------------	----------	------------

Balkenauflegeplatte F-Modell

07985	125 *	127497	b=71 mm	1/9-1/11 25x9-20x14-3/30x14	100x300	80x8	S315 TV
079851	100 *	127787	b=71 mm	1/9-1/11 25x9-20x14-3/30x14	100x300	80x10	S315 TV
07984	125 *	035945	b=59 mm	1/9-1/11 25x9-20x14-3/30x14	100x300	80x8	S315 EV
07986	125 *	033996	b=71 mm	1/9-1/11 25x9-20x14-3/30x14	100x300	80x8	S315 EV
079861	100 *	031350	b=71 mm	1/9-1/11 25x9-20x14-3/30x14	100x300	80x10	S315 EV



* auch Stückweise lieferbar



Art.Nr. 07984

Balkenauflegeplatte F-Modell geschweißt

NEU

079919	1	056629	b=71 mm	NEU 4/9-2/14 2/24x14	70x250	80x8	S315 EV
079920	1	026165	b=71 mm	NEU 4/9-2/14 2/24x14	70x250	80x10	S315 EV
079924	1	056636	b=71 mm	NEU 4/9-2/14 2/24x14	70x670	80x8	S315 EV
079925	1	026172	b=71 mm	NEU 4/9-2/14 2/24x14	70x670	80x10	S315 EV
079935	1	052874	b=71 mm	NEU 4/9-2/14 2/24x14	140x280	70x10	S315 EV
079939	1	056650	b=71 mm	NEU 4/9-2/14 2/24x14	150x250	80x8	S315 EV
079940	1	026189	b=71 mm	NEU 4/9-2/14 2/24x14	150x250	80x10	S315 EV
079944	1	056667	b=71 mm	NEU 4/9-2/14 2/24x14	150x670	80x8	S315 EV
079945	1	026196	b=71 mm	NEU 4/9-2/14 2/24x14	150x670	80x10	S315 EV

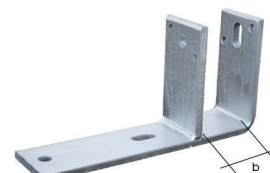

Art.Nr. 079940

Balkenauflegeplatte F-Modell geschweißt

NEU

0797584	1	038533	b=71 mm	NEU	127x480	50x8	S315 EV
----------------	---	--------	---------	------------	---------	------	----------------



Art.Nr. 0797584

Balkenauflegeplatte F-Modell geschweißt

NEU

07982	1	039073	b=71 mm	5/13-1/14 50x13	275x400	80x8	S315 TV
07983	1	039080	b=71 mm	2/14 2/24x14	175x315	80x8	S315 TV
079949	1	052881	b=71 mm	NEU 4/9-2/14 2/24x14	240x360	80x8	S315 EV
079950	1	026202	b=71 mm	NEU 4/9-2/14 2/24x14	240x360	80x10	S315 EV
079929	1	056643	b=71 mm	NEU 4/9-2/14 2/24x14	240x670	80x8	S315 EV
079930	1	030612	b=71 mm	NEU 4/9-2/14 2/24x14	240x670	80x10	S315 EV

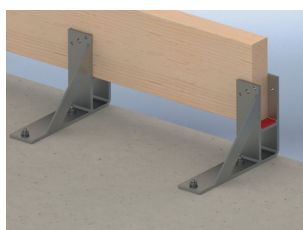

Art.Nr. 079950

EV = elektrolytisch verzinkt; TV = feuerverzinkt

Zugfestigkeit S315 = 315 N/mm²

Artikel Nr.	Verp. (Bestell) Einheit	EAN-Code Verpackung 8714318	Holzmaß	Lochmuster/ Langlöcher Anzahl / mm	Abmessung mm	Größe mm	Oberfläche
-------------	-------------------------	-----------------------------	---------	------------------------------------	--------------	----------	------------

Balkenauflegeplatte

NEU



Art.Nr. 079873

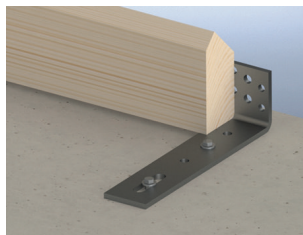

079871	5	051402	2/11-4/13		70x17	60x350	70x8	S315	TV
079875	5	054434	2/11-5/13	NEU	70x17	80x330	70x8	S315	TV
079873	5	051419	4/11-5/13		70x17	90x320	70x8	S315	TV
079874	5	051440	6/11-5/13		70x17	120x290	70x8	S315	TV
079877	5	127961	2/9-1/11-5/13		70x17	70x725	70x8	S315	TV
079881	5	051457	2/11-4/13		70x17	60x350	70x10	S315	TV
079883	5	051471	4/11-5/13		70x17	90x320	70x10	S315	TV
079884	5	051495	6/11-5/13		70x17	120x290	70x10	S315	TV
079893	5	052287	4/11-5/13	NEU	70x17	90x320	70x8	S315	EV
079911	5	052300	2/11-4/13	NEU	70x17	60x350	70x10	S315	EV
079913	5	052331	4/11-5/13	NEU	70x17	90x320	70x10	S315	EV

Hakenscharauben

05201	100	125790	M10		200x50	dl>90	VD
05202	100	125806	M10		250x50	dl>90	VD
05203	100	125813	M10		300x50	dl>90	VD
05205	100	125837	M10		400x50	dl>90	VD
05226	100	125844	M12		200x50	dl>120	VD
05227	100	125851	M12		250x50	dl>120	VD
05228	100	125875	M12		300x50	dl>120	VD
05230	50	125820	M12		400x50	dl>120	VD
05232	50	125899	M12		500x50	dl>120	VD
05234	25	125868	M12		600x50	dl>120	VD
05238	25	125882	M12		800x50	dl>120	VD
05352	25	117597	M16		250x55	dl>120	EV
05353	25	101732	M16		300x55	dl>120	EV
05354	25	116248	M16		350x55	dl>120	EV
05355	25	101749	M16		400x55	dl>120	EV
05355	500	116170	M16 = Palettenabnahme		400x55	dl>120	EV
05357	25	101756	M16		500x55	dl>120	EV
05357	500	116194	M16 = Palettenabnahme		500x55	dl>120	EV
05360	25	050856	M16		600x55	dl>120	EV
05380	25	101763	M20		400x60	dl>120	EV
05380	500	116026	M20 = Paletten Abnahme		400x60	dl>120	EV
05382	25	101770	M20		500x60	dl>120	EV
05382	500	116033	M20 = Paletten Abnahme		500x60	dl>120	EV
05384	20	050863	M20		600x60	dl>120	EV
05395	15	117283	M24		400x100	dl>120	EV
05396	15	117290	M24		500x100	dl>120	EV
05397	5	050894	M24		600x100	dl>120	EV
05153	25	101558	M16		300x55	dl>120	BL
05155	25	101565	M16		400x55	dl>120	BL
05157	25	101572	M16		500x55	dl>120	BL
05160	25	050917	M16		600x55	dl>120	BL
05180	25	101589	M20		400x60	dl>120	BL
05182	25	101596	M20		500x60	dl>120	BL
05184	20	050931	M20		600x60	dl>120	BL
05195	15	117269	M24		400x100	dl>120	BL
05196	15	117276	M24		500x100	dl>120	BL
05197	5	050955	M24		600x100	dl>120	BL



dl = Gewindelänge
Weitere Größen auf Anfrage

BL = Blank; EV = elektrolytisch verzinkt; TV = feuerverzinkt;
VD = verzinkter Draht

Zugfestigkeit S315 = 315 N/mm²

Artikel Nr.	Verp. (Bestell) Einheit	EAN-Code Verpackung	Holzmaß / Isolierstärke	Abmessung mm	Größe mm	Oberfläche
		8714318				

Mauerwerksmontageplatte M12

069080	25	046064	Isolierstärke 80	80	2,5	SV
069100	25	046088	Isolierstärke 100	100	2,5	SV
069120	25	046101	Isolierstärke 120	120	2,5	SV



Steinanker mit Platte zentrisch - max. Schalenabstand 50 mm

06530	25	033262	M12	400 PL 150	dl>120	VD
06532	10	125035	M12	500 PL 150	dl>120	VD
06534	10	125042	M12	600 PL 150	dl>120	VD
06538	10	125059	M12	800 PL 150	dl>120	VD
06542	10	125066	M12	1000 PL 150	dl>120	VD

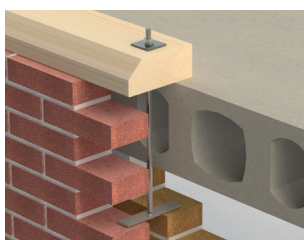

dl = Gewindelänge

Steinanker mit Platte exzentrisch - max. Schalenabstand 175 mm

06570	25	033286	M12	400 PL 225	dl>120	VD
06572	10	125080	M12	500 PL 225	dl>120	VD
06574	10	125097	M12	600 PL 225	dl>120	VD
06576	10	125103	M12	800 PL 225	dl>120	VD
06578	10	125110	M12	1000 PL 225	dl>120	VD

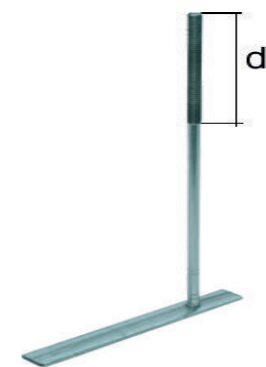
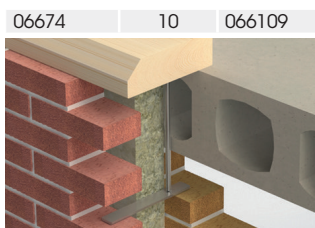

dl = Gewindelänge

Ankerplatte für Dünnbettfugen

21204	50	101909	M12		1,25	SV
-------	----	--------	-----	--	------	----

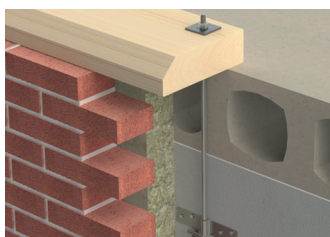

Montage mit Unterlegscheibe M12

SV = sendzimir verzinkt; VD = verzinkter Draht

Artikel Nr.	Verp. (Bestell) Einheit	EAN-Code Verpackung 8714318	Anzahl der Bohrungen Anzahl / mm	Abmessung mm	Größe mm	Oberfläche
-------------	-------------------------	-----------------------------	----------------------------------	--------------	----------	------------

Flachstahl-Winkel mit Wulst



07939	50	102746	12/4-2/9	150x250	30x2	SV
-------	----	--------	----------	---------	------	----

Windsoganker Typ A



079400	25	102753	10/4-5/9	500x40	30x2	SV
079410	25	026912	10/4-5/9	750x40	30x2	SV

Windsoganker Typ B



079420	25	102777	10/4-5/9	780	30x2	SV
--------	----	--------	----------	-----	------	----

Windsoganker



07944	25	102784	10/4-5/9	400x40	30x2	SV
07945	25	102791	10/4-5/9	500x40	30x2	SV
07946	25	102807	10/4-5/9	600x40	30x2	SV
07947	25	102814	10/4-5/9	750x40	30x2	SV
07948	25	102821	10/4-5/9	1000x40	30x2	SV

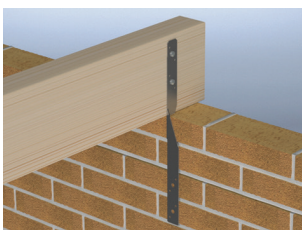

SV = sendzimir verzinkt

Artikel Nr.	Verp. (Bestell) Einheit	EAN-Code Verpackung	Anzahl der Bohrungen Anzahl / mm	Abmessung mm	Größe mm	Oberfläche
		8714318				

Windsoganker

079445	1	031268	10/4-5/9	350x55x40	30x2	SV
--------	---	--------	----------	-----------	------	----



Windsoganker

13413	25	123307	3/6	600	Ø10	VD
13415	25	123291	3/6	800	Ø10	VD



Art.Nr. 13413



Artikel Nr.	Verp. (Bestell) Einheit	EAN-Code Verpackung	Anzahl der Bohrungen	Abmessung mm	Größe mm	Oberfläche
		8714318	Anzahl / mm			

Balkenanker



00401	20	102630	3/7	240x240	Ø14,5	EV
-------	----	--------	-----	---------	-------	----

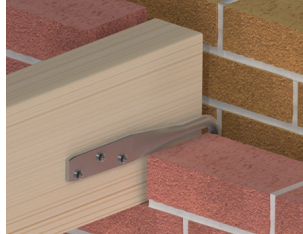

Balkenanker

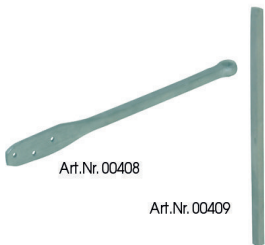

00408	1	002787	Feder	450	#16	TV
00409	1	002794	Querstab	400	#16	TV

Zuganker

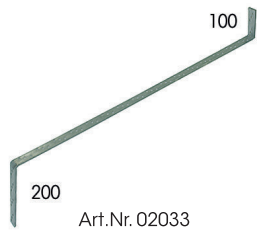

02031	10	102654	60/6	700	30x5	VB
02033	10	102661	66/6	800	30x5	VB
02035	10	102678	72/6	900	30x5	VB
02037	10	102685	78/6	1000	30x5	VB

Mauerplattenhaken



04029	10	102692	42/6	600	30x5	VB
04033	10	102708	54/6	800	30x5	VB
04035	10	102715	60/6	900	30x5	VB
04037	10	102722	66/6	1000	30x5	VB
04039	10	102739	78/6	1200	30x5	VB

HSB-Zuganker mit 2 Unterlegscheiben

NEU



074916	25	056421	9/5-1/14	NEU	160x50	40x2	SV
074919	25	056407	11/5-1/14	NEU	190x50	40x2	SV
074929	25	056445	17/5-1/14	NEU	290x50	40x2	SV

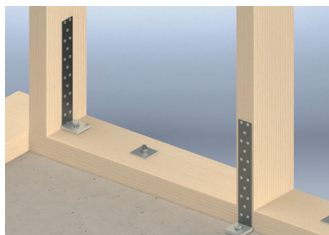

Artikel Nr.	Verp. (Bestell) Einheit	EAN-Code Verpackung	Anzahl der Bohrungen Anzahl / mm	Langloch	Abmessung mm	Größe mm	Oberfläche
-------------	-------------------------	---------------------	----------------------------------	----------	--------------	----------	------------

Sparrenwinkel

07931	100	105877	12/4		250-125x125	35x35x2	SV
07932	100	105884	12/4	gespiegelt	125x125-250	35x35x2	SV

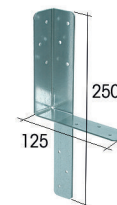

Art.Nr. 07931

Eckverbinder

07934	50	105891	8/4		110	30x30x2	SV
07935	50	105907	12/4		200	30x30x2	SV
07936	50	105914	12/4		300	30x30x2	SV



Art.Nr. 07931

Ankerstreifen gedreht

0797170	50	045074	4/4		170	30x2	SV
0797200	50	045098	6/4		200	30x2	SV
0797230	50	045111	6/4		230	30x2	SV



Art.Nr. 0797200

Winkelverbinder schwer

82420	25	106577	4/7	90 °	100x150	25x5	EV
82421	25	106584	4/7	135 °	100x150	25x5	EV



EV = elektrolytisch verzinkt; SV = sendzimir verzinkt

Artikel Nr.	Verp. (Bestell) Einheit	EAN-Code Verpackung 8714318	Anzahl der Bohrungen Anzahl / mm	Abmessung mm	Größe mm	Oberfläche
-------------	-------------------------	-----------------------------	----------------------------------	--------------	----------	------------

Winkelverbinder 135°

072200	100	033194	10/4-6/6-4/9-1/11	30x11	180 60x2,5	SV
--------	-----	--------	-------------------	-------	------------	----



T-Träger Balkenanker

00501	100	102647	3/7		155 46x2,5	SV
-------	-----	--------	-----	--	------------	----

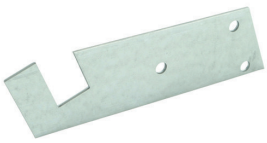

Windrispenband

NEU

85454	1	006853	2/4-1/6		10 mtr	20x1	SV	
85455	1	006860	2/4-1/6		25 mtr	20x1	SV	
85453	1	118488	4/4-1/8,5	14x4	25 mtr	25x1	SV	
854541	1	053987	2/4-1/6	NEU	10 mtr	20x1,5	SV	
854551	1	000035	2/4-1/6		25 mtr	20x1,5	SV	
85456	1	006877	2/4-1/8		14x4	10 mtr	30x1,5	SV
85457	1	006884	2/4-1/8		14x4	25 mtr	30x1,5	SV
8545815	1	056483	2/5-1/5	NEU *Hohe Zugfestigkeit	50 mtr	40x1,5	S350 SV	
8545905	1	065768	3/5-2/5	NEU *Hohe Zugfestigkeit	10 mtr	60x1,5	S350 SV	
8545908	1	065775	3/5-2/5	NEU *Hohe Zugfestigkeit	25 mtr	60x1,5	S350 SV	
8545915	1	065782	4/5-3/5	NEU *Hohe Zugfestigkeit	25 mtr	80x1,5	S350 SV	
8545825	1	005191	2/5-1/5	NEU	25 mtr	40x2	SV	
85458	1	006891	2/5-1/5		50 mtr	40x2	SV	
8545925	1	045302	3/5-2/5		25 mtr	60x2	SV	
854854	1	055677	2/4-1/6	NEU	10 mtr	20x1	304	
854855	1	055684	2/4-1/6	NEU	25 mtr	20x1	304	
854856	1	055691	2/4-1/8	NEU	14x4	10 mtr	30x1,25	304
854857	1	055707	2/4-1/8	NEU	14x4	25 mtr	30x1,25	304
854858	1	055851	2/4-1/8	NEU	14x4	10 mtr	30x1,5	304
854859	1	055868	2/4-1/8	NEU	14x4	25 mtr	30x1,5	304
854515	1	999582	2/5-1/5		5 mtr	40x2	SV	
854516	1	999599	2/5-1/5		6 mtr	40x2	SV	
854517	1	999605	2/5-1/5		7 mtr	40x2	SV	
854518	1	999612	2/5-1/5		8 mtr	40x2	SV	
854525	1	999629	3/5-2/5		5 mtr	60x2	SV	
854526	1	999636	3/5-2/5		6 mtr	60x2	SV	
854527	1	999643	3/5-2/5		7 mtr	60x2	SV	
854528	1	999650	3/5-2/5		8 mtr	60x2	SV	
861012	1	059262	5 in blauer Cassette, flach	NEU	10 mtr	12x0,8	SV	
861017	1	059279	7 in blauer Cassette, flach	NEU	10 mtr	17x0,8	SV	
861112	1	060916	5 in blauer Cassette, wave	NEU	10 mtr	12x0,8	SV	
861117	1	060923	7 in blauer Cassette, wave	NEU	10 mtr	17x0,8	SV	
861212	1	059286	5 in schwarzer Cassette, wave	NEU	10 mtr	12x0,8	304	

Art.Nr. 85454

Art.Nr. 861017

Art.Nr. 861212

304 = RVS VA2; SV = sendzimir verzinkt

Artikel Nr.	Verp. (Bestell) Einheit	EAN-Code Verpackung	Bezeichnung Anzahl der Bohrungen Anzahl / mm	Abmessung	Material	Oberfläche
-------------	-------------------------	---------------------	--	-----------	----------	------------

Firstplattenhalter

07927	50	105846	16/4	b=28	40x1,5	SV
07928	50	105853	16/4	b=32	40x1,5	SV
07929	50	105860	16/4	b=38	40x1,5	SV

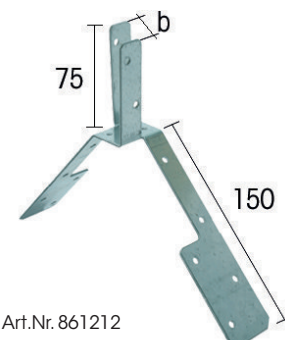
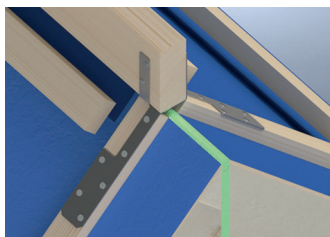

Art.Nr. 861212

Pfannenklammern

85239	1000	108038	Pfannenklammern Typ Fries	85x50x60x60	Ø2,9	316 O.G.
85241	1000	108045	Pfannenklammern Typ Fries	85x50x60x60	Ø2,9	VD
85248	1000	108052	Pfannenklammern	80x40x40	Ø3,6	VD
85440	250	032524	Pfannenklammern	80x40x40	1,25	SV

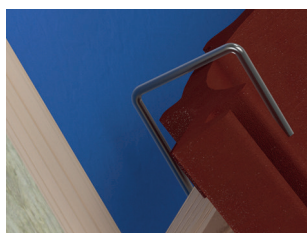

Art.Nr. 85539,85241



Art.Nr. 85248



Art.Nr. 85440

Stahlklemmscheibe

NEU

86065	500	060565	ohne Loch (in Kunststoffdose verpackt)	NEU	Ø 70	0,6	SV
86068	250	123260	1/6 (in Kunststoffdose verpackt)		Ø 70	0,6	SV
86068	500	040062	1/6 (im Beutel verpackt)		Ø 70	0,6	SV



316 O.G. = RVS VA4 oder gleichwertig; SV = sendzimir verzinkt; VD = verzinkter Draht

Artikel Nr.	Verp. (Bestell) Einheit	EAN-Code Verpackung 8714318	Anzahl der Bohrungen Anzahl / mm	Langloch mm	Abmessung mm	Größe mm	Oberfläche
-------------	-------------------------	-----------------------------	----------------------------------	-------------	--------------	----------	------------

Winkelverbinder 27x68

NEU

072300	50	055462	6/5,3-1/9	NEU	40x13	27x68	57x2	SV
--------	----	--------	-----------	-----	-------	-------	------	----



Winkelverbinder 40x60

NEU

072302	100	116521	10/4-2/6-2/9-1/11		30x11	40x60	60x2	SV
072301	100	113322	10/4-2/6-2/9-1/11		30x11	40x60	60x2,5	SV
070301	100	055943	8/4-4/6-2/9-1/11	NEU	30x11	40x60	60x2,5	S350 ZM
07130	100	106287	10/4-2/6-2/9-1/11		30x11	40x60	60x2	304



Winkelverbinder 40x80

07234	100	106393	6/6		30x9	40x80	46x2,5	SV
-------	-----	--------	-----	--	------	-------	--------	----



Winkelverbinder 40x100

07232	100	106379	12/4-1/11		40x12	40x100	60x2,5	SV
07132	100	106294	12/4-1/11		40x12	40x100	60x2	304

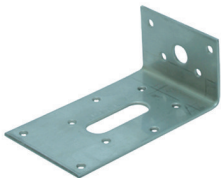

Winkelverbinder 50x50

07236	100	106409	12/4		30x9-30x12	50x50	58x2,5	SV
0723610	100	045364	12/4		30x9-30x12	50x50	58x2	SV
07136	100	125745	12/4		30x9-30x12	50x50	60x2	304



304 = RVS VA2; SV = sendzimir verzinkt; ZM = Zink Magnesium

Artikel Nr.	Verp. (Bestell) Einheit	EAN-Code Verpackung	Anzahl der Bohrungen Anzahl / mm	Langloch mm	Abmessung mm	Größe mm	Oberfläche
-------------	-------------------------	---------------------	----------------------------------	-------------	--------------	----------	------------

Winkelverbinder 50x75 mit 2 Wülsten

07233	100	106386	8/4-4/6-2/9		50x75	57x2	SV
-------	-----	--------	-------------	--	-------	------	----



Winkelverbinder 50x90

07249	100	114350	6/4-4/6-2/9	12x4-24x6-24x8,5	50x90	57x2,5	SV
07149	100	114367	6/4-4/6-2/9	12x4-24x6-24x8,5	50x90	57x2	304



Winkelverbinder 50x110

NEU

072350	50	056582		30x11-2/40x11 dia.	NEU 50x110	60x3	SV
--------	----	--------	--	--------------------	------------	------	----

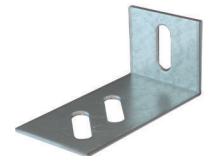
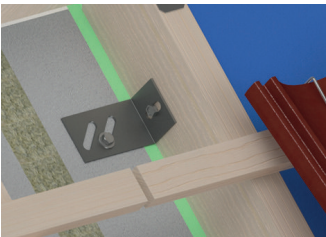

Winkelverbinder 60x60

07231	100	125509	10/4,5-4/6,5	2/30x11	60x60	57x2	SV
-------	-----	--------	--------------	---------	-------	------	----



Winkelverbinder 60x80 / 60x120 / 60x180 mit Wulst

072381	100	125622	4/4-8/6-1/9	25x11	60x80	60x2,5	SV
072383	100	125639	6/4-11/6-1/9	2/25x11	60x120	60x2,5	SV
072385	50	125141	8/4-14/6-1/9	3/25x11	60x180	60x2,5	SV

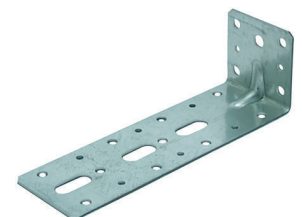

Artikel Nr.	Verp. (Bestell) Einheit	EAN-Code Verpackung 8714318	Anzahl der Bohrungen Anzahl / mm	Langloch mm	Abmessung mm	Größe mm	Oberfläche
-------------	-------------------------	-----------------------------	----------------------------------	-------------	--------------	----------	------------

Winkerverbinder 70x70 / 70x70 mit Wulst

NEU

072215	100	061531	4/5-8/7-1/9		25x11	NEU 70x70	57x2	SV
072216	100	061555	4/5-8/7-1/9	mit Wulst	25x11	NEU 70x70	57x2	SV



Winkerverbinder 75x125 / 90x160 mit Wulst

07244	100	116422	10/4-2/9			75x125	30x2	SV
07245	100	116415	12/4-1/7-2/9			90x160	30x2	SV



Winkerverbinder 75x125 mit Wulst (Porenbeton)

072445	100	125585		2/12x5 5/17x8		75x125	30x2	SV
--------	-----	--------	--	---------------	--	--------	------	----



Winkerverbinder 90x90

NEU

072222*	100	124557	14/4-6/6-4/9-1/11		30x11	90x90	60x2	SV
072220*	100	113162	10/4-6/6-4/9-1/11		30x11	90x90	60x2,5	SV
070220*	100	055912	10/4-6/6-4/9-1/11		30x11	NEU 90x90	60x2,5	ZM
07122*	100	106270	14/4-6/6-4/9-1/11		30x11	90x90	60x2	304

* CE = Zertifiziert



304 = RVS VA2; SV = sendimir verzinkt; ZM = Zink Magnesium

Artikel Nr.	Verp. (Bestell) Einheit	EAN-Code Verpackung 8714318	Anzahl der Bohrungen Anzahl / mm	Langloch mm	Abmessung mm	Größe mm	Oberfläche
-------------	-------------------------	-----------------------------	----------------------------------	-------------	--------------	----------	------------

Winkelverbinder 90x90 mit Wulst NEU

072232*	100	124564	14/4-6/6-4/9-1/11	30x11	90x90	60x2	SV
072230*	100	113179	10/4-6/6-4/9-1/11	30x11	90x90	60x2,5	SV
070230*	100	056537	10/4-6/6-4/9-1/11	30x11	NEU 90x90	60x2,5	ZM
07123*	100	109103	14/4-6/6-4/9-1/11	30x11	90x90	60x2	304
07124	100	067298	14/4-6/6-4/9-1/11	30x11	NEU 90x90	60x2	316

* CE = Zertifiziert



Winkelverbinder 90x150

07237*	50	106416	12/4-8/6-5/9-2/11	30x11	90x150	60x2,5	SV
--------	----	--------	-------------------	-------	--------	--------	----

* CE = Zertifiziert



Winkelverbinder 90x150 mit Wulst

07239*	50	106423	12/4-8/6-5/9-2/11	30x11	90x150	60x2,5	SV
--------	----	--------	-------------------	-------	--------	--------	----

* CE = Zertifiziert

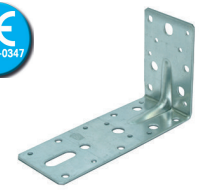

Winkelverbinder 125x125

07225*	50	106324	10/4-6/6-1/11	20x10	125x125	46x2,5	SV
--------	----	--------	---------------	-------	---------	--------	----

* CE = Zertifiziert



Winkelverbinder 125x125 mit Wulst

07226*	50	106331	10/4-6/6-1/11	20x10	125x125	46x2,5	SV
--------	----	--------	---------------	-------	---------	--------	----

* CE = Zertifiziert



304 = RVS VA2; 316 O.C. = RVS VA4 oder gleichwertig; SV = sendzimir verzinkt; ZM = Zink Magnesium

	Artikel Nr.	Verp. (Bestell) Einheit	EAN-Code Verpackung	Artikelbeschreibung Anzahl der Bohrungen Anzahl / mm	Abmessung mm	Größe mm	Oberfläche
--	-------------	-------------------------	---------------------	--	--------------	----------	------------

150x150

07228*	50	106348	15/4-10/6-5/9	2/30x11	150x150	60x2,5	SV
--------	----	--------	---------------	---------	---------	--------	----

* CE = Zertifiziert



150x150 mit Wulst

07229*	50	106355	15/4-10/6-5/9	2/30x11	150x150	60x2,5	SV
--------	----	--------	---------------	---------	---------	--------	----

* CE = Zertifiziert



100x75

0721910	50	049539	9/5-4/7	7x12-7x20-7x27-5x21-5x26	100x75	1,5	SV
---------	----	--------	---------	--------------------------	--------	-----	----

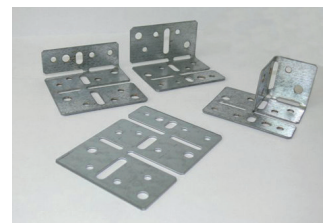

SV = sendzimir verzinkt

Artikel Nr.	Verp. (Bestell) Einheit	EAN-Code Verpackung	Anzahl der Bohrungen Anzahl / mm	Langloch mm	Abmessung mm	Größe mm	Oberfläche
-------------	-------------------------	---------------------	----------------------------------	-------------	--------------	----------	------------

Eye-safe für Winkelverbinder

34320	250	036294			68x5,8		KS
-------	-----	--------	--	--	--------	--	----

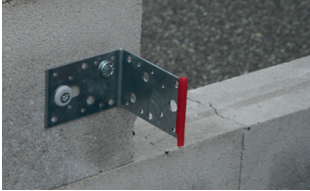

Um Verletzungen während des Bauens zu vermeiden



Gerüstbrettband

85445	250	118471	Gerüstbrettband mit Namenseindruck	400	22x0,7	SV
85447	250	108816	Gerüstbrettband mit runder Kante	400	22x0,7	SV

Mit Namensdruck auf Anfrage lieferbar.



Möbelwinkel

82396	100	103200	4/4,5	30x30	10x2	GP
82397	100	103217	4/4,5	40x40	10x2	GP



Stuhlwinkel

82401	250	106454	4/5	25x25	15x2	EV
82402	250	106461	4/5	40x40	15x2	EV
82403	100	106478	4/5	55x55	15x2	EV
824032	100	123345	4/5	70x70	20x2	EV
82405	100	106485	6/5	80x80	20x2	EV
82406	100	106492	6/5	100x100	20x2	EV
82408	100	108571	4/6,5	125x125	20x3	EV
82409	25	108564	4/6,5	150x150	25x3	EV
824015	250	116453	4/5	25x25	15x2	ZM
824025	250	116460	4/5	40x40	15x2	ZM
824035	100	116477	4/5	55x55	15x2	ZM
824055	100	116484	6/5	80x80	20x2	ZM
824065	100	116491	6/5	100x100	20x2	ZM

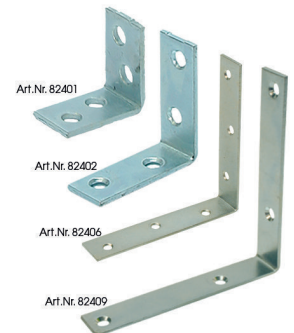

EV = elektrolytisch verzinkt; GP = gelb passiviert; KS = Kunststoff;
SV = sendzimir verzinkt; ZM = Zink Magnesium

Blauer Text = nur noch lieferbar solange der Vorrat reicht

Artikel Nr.	Verp. (Bestell) Einheit	EAN-Code Verpackung 8714318	Anzahl der Bohrungen Anzahl / mm	Abmessung mm	Größe mm	Oberfläche
-------------	-------------------------	-----------------------------	----------------------------------	--------------	----------	------------

Breitwinkel

NEU

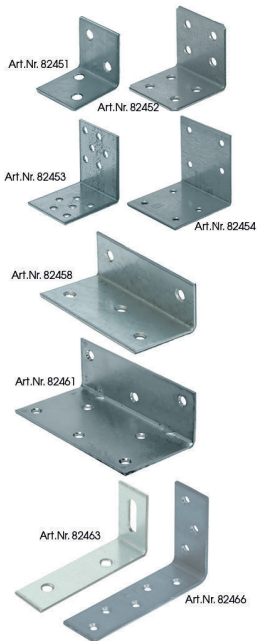

82451	250	106591	4/4,5		30x30	30x2	SV
82452	250	106607	8/4,5		40x40	40x2	SV
82453	100	108960	12/4,5		50x50	40x2	SV
824531	100	060343	8/5		NEU 50x50	40x2	SV
82454	100	106614	8/4,5		60x60	57x2	SV
82458	100	108793	5/6		40x25	75x2	SV
82459	100	047702	3/4		40x20	50x2	SV
82460	100	045807	4/4		40x20	100x2	SV
82461	50	055233	8/6		60x40	115x2,5	SV
82463	100	999223	2/5	20x6	NEU 70x35	20x2	ZM
82465	50	108557	5/5,5		105x75	30x2,5	SV
82466	50	115708	8/5,5		130x80	36x4	SV
82467	50	045449	4/5		57x57	36x4	SV
82653	100	045395	12/4,5		50x50	40x2	304

Stuhlwinkel schwer

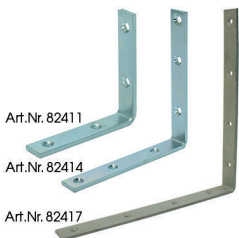

82411	25	106508	4/6		100x100	20x5	EV
82412	25	106515	4/6		125x125	20x5	EV
82413	25	106522	4/7		150x150	25x5	EV
82414	25	106539	6/7		175x175	25x5	EV
82415	25	106546	6/7		200x200	25x5	EV
824165	25	116316	6/7		250x250	30x6	EV
824175	25	116446	8/7		300x300	30x6	EV
82416	25	106553	6/7		250x250	30x6	TV
82417	25	106560	8/7		300x300	30x6	TV

Einlassecken 90°



83100	100	126483	4/3,5		30x30	10x1,5	ZM*
83101	100	126490	4/3,5		40x40	10x1,5	ZM*
83102	100	126506	4/3,5		50x50	10x1,5	ZM*
83103	100	125783	4/3,5		60x60	10x1,5	ZM*
83104	100	125592	4/3,5		70x70	14x2	ZM*
83105	100	102944	4/4		80x80	17x1,5	ZM*
83106	100	102951	4/4		100x100	18x1,5	ZM*
83107	100	102968	4/4,5		120x120	19x1,5	ZM*
83108	100	127398	6/5,5		150x150	22x2	ZM*
83305	25	106706	6/6,5		200x200	28x3	EV
83306	25	106713	6/6		250x250	32x3	EV
83307	25	106720	8/6		300x300	36x4	EV

* kann auch galvanisiert geliefert werden.

Artikel Nr.	Verp. (Bestell) Einheit	EAN-Code Verpackung	Anzahl der Bohrungen	Langloch	Abmessung mm	Größe mm	Oberfläche
		8714318					

Kreuzwinkel

83321	25	126872	8/4		130	11x2	ZM*
-------	----	--------	-----	--	-----	------	-----

* kann auch galvanisiert geliefert werden.

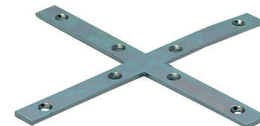

T-Winkel

83330	100	103804	6/3		35x70	16x1,5	GP
-------	-----	--------	-----	--	-------	--------	----

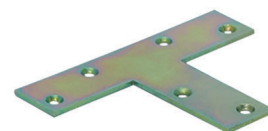

Artikel Nr.	Verp. (Bestell) Einheit	EAN-Code Verpackung 8714318	Abwendung Anzahl / mm	Abmessung mm	Größe mm	Oberfläche
-------------	-------------------------	-----------------------------	-----------------------	--------------	----------	------------

Ankernägeln mit Drallgewinde



07206	1000	102869	Holzstärke > 35 mm	32	Ø3,8	EV
07207	500	102876	Holzstärke > 70 mm	65	Ø3,8	EV
072062	1000	113933	Holzstärke > 35 mm	32	Ø3,8	304

Kammnägeln



07204	250	108885	Holzstärke > 45 mm	40	Ø4,2	EV
-------	-----	--------	--------------------	----	------	----

Stahlnägeln Z1



07205	500	102852	Bohrloch Ø4x50	40	Ø4,5	EV
-------	-----	--------	----------------	----	------	----

Schraubnägeln



072080	250	113506	Holzstärke > 50 mm	45	Ø5	GP
--------	-----	--------	--------------------	----	----	----

Schraubnägeln mit Kragendübel



07215	200	113513	Bohrloch Ø8x50	5x50	8x40	EVNY
-------	-----	--------	----------------	------	------	------



Spreizdübel

NEU



Art.Nr. 072140

072140	50	103187	Bohrloch Ø12 min. 55mm	Typ: ZA S 12	12/-	50	EV
072100	50	102890	Bohrloch Ø12 min. 55mm	Typ: ZA S 12	12/10	60	EV
072110	50	102906	Bohrloch Ø12 min. 55mm	Typ: ZA S 12	12/50	105	EV
0721860	50	055585	Bohrloch Ø12 min. 60mm	Typ: TA M 8-NL	12x60	NEU	EV
0721890	25	055608	Bohrloch Ø12 min. 60mm	Typ: TA M 8-NL	12x90	NEU	EV



Art.Nr. 0721890

Artikel Nr.	Verp. (Bestell) Einheit	EAN-Code Verpackung 8714318	Anzahl der Bohrungen	Abmessung mm	Größe mm	Oberfläche
-------------	-------------------------	-----------------------------	----------------------	--------------	----------	------------

Konsolenstütze

824223	10	047344	4/7	150x200	20x4/20x4	VB
82425	10	033941	6/7	200x300	30x4/20x4	VB
82427	10	033958	6/7	250x400	30x4/20x4	VB
82435	10	033965	6/7	300x500	30x4/20x4	VB
824222	10	047320	4/7	150x200	20x4/20x4	EPW
824260	10	103651	6/7	200x300	30x4/20x4	EPW
824280	10	103125	6/7	250x400	30x4/20x4	EPW
824360	10	103132	6/7	300x500	30x4/20x4	EPW

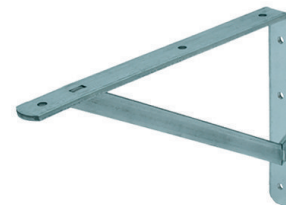

Art.Nr. 82425

Konsolenstütze demontiert

824221	2	047306	2/6-2/8	150x200	25x4/15x15x2	EV
82423	2	039103	3/6-3/8	250x300	25x5/15x15x2	EV
82429	2	039127	3/6-3/8	325x400	25x5/15x15x2	EV
82439	2	039141	3/6-3/8	400x500	25x5/15x15x2	EV
824224	2	047368	2/6-2/8	150x200	25x4/15x15x2	EPW
82424	2	113858	3/6-3/8	250x300	25x5/15x15x2	EPW
82430	2	113865	3/6-3/8	325x400	25x5/15x15x2	EPW
82440	2	113872	3/6-3/8	400x500	25x5/15x15x2	EPW



Art.Nr. 82424

Balkenträger mit Keilbolzen

82444	10	114855	3/3,5	120x30		EV
82445	10	114848	3/3,5	150x30		EV
82448	10	114831	3/3,5	180x30		EV
82449	10	114824	3/3,5	220x30		EV
82450	10	114817	3/3,5	250x30		EV



Art.Nr. 82449

EPW = Weiß beschichtet; EV = elektrolytisch verzinkt;
VB = verzinktes Band;